

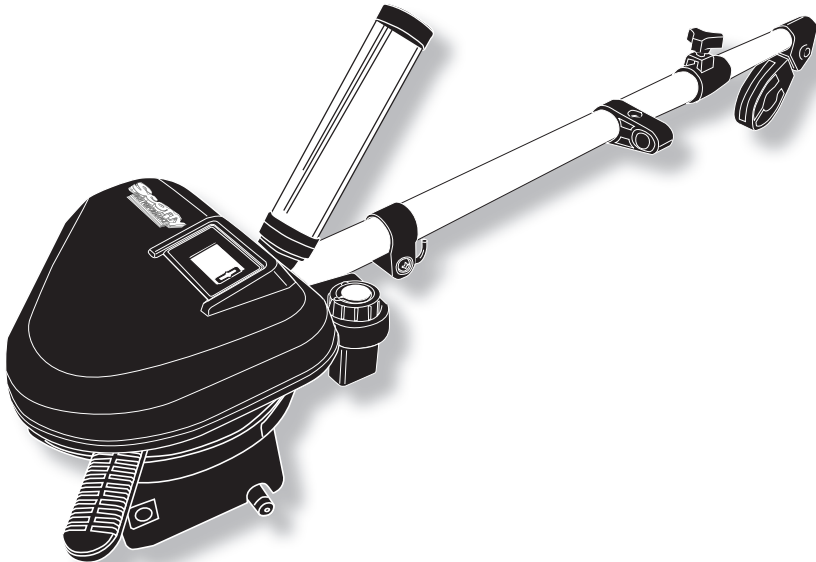

The Way To Fish™

HIGH PERFORMANCE ELECTRIC DOWNRIGGER

- Installation • Maintenance •
- Use and Safety •



CAUTION! Read through this entire booklet before operating your Scotty Downrigger. Improper use may damage your downrigger and void the warranty. You may also expose yourself to unnecessary danger and physical injury.

Electric Downrigger Manual

Thank you for choosing a Scotty Downrigger. In 1973 Scotty produced its first downrigger. Our goal was to manufacture a superior downrigger, built to withstand the demanding marine environment, and we now produce many manual and electric models. This instruction book will give you basic instruction on mounting and using your downrigger. **Please read carefully.** It will improve your results and also give you important tips on downrigger safety and care. Good Fishing!

Features

Original Purchaser Limited Lifetime Warranty

Scotty is proud to warranty your High Performance Downrigger for the lifetime of the original owner. To register your factory authorized warranty you must send your completed warranty card along with proof of purchase and serial number (found under your downrigger lid) to Scotty, either online, mail or fax. For warranty inquiries, please contact Scotty Fishing, Marine and Outdoors at 1-800-214-0141 or 250-656-8102, or one of our authorized warranty repair service depots (see www.scotty.com or call us for the depot nearest you). We will do our best to get you back fishing as soon as possible.

Speed & Efficiency

The Scotty High Performance Downrigger's drive mechanism incorporates a positive drive gear belt to turn the downrigger spool. This highly efficient belt system is used by many auto makers for valve timing, and the benefit to the fisherman is that power is transferred from the motor at a greater efficiency than worm gear drives used in most electric downriggers. The result is a faster retrieval speed with less electric power used. The Scotty High Performance Downrigger will retrieve at speeds two to three times faster than most electrics.

Clutch Brake

The Scotty clutch brake allows descent of the downrigger weight at any speed you choose. Most of the time you will want a slow, even descent speed to avoid tangles. However, in instances where you want a lure deep very quickly, the Scotty HP will respond, giving you complete control. The clutch brake has been factory set to pay-out if you hang up on the bottom, but must be calibrated for your particular environment. Changes in temperature, humidity or the amount of weight you use with your downrigger will alter the performance of the brake. You must adjust the brake to suit your particular conditions prior to each use. See page 13 for step by step instructions on how to adjust the brake.

Auto-Stop

Auto-Stop control permits hands-free line retrieval and Scotty line beads (pre-installed on your downrigger) allow you to stop your downrigger at any preset point. Scotty line beads can be positioned anywhere on your downrigger line and must be checked prior to each use to confirm they are present and properly located. Missing or improperly located line beads will not turn the unit off in its desired location. The downrigger will continue to retrieve beyond the point where you want it to stop and may cause line failure or terminal tackle failure and may result in personal injury.

Digital counter

The Scotty HP downrigger uses a hermetically sealed digital line counter to show the depth of your downrigger weight. Press the "light" icon to illuminate the counter for approximately 30 seconds (it will turn off by itself). To reset the counter to zero, press and hold the "zero" icon for approximately 5 seconds. Because the digital counter draws such a small amount of current from the battery, the counter will remain on at all times. Under normal use the counter should last over 4 years, but heavy use of the back-light will greatly reduce the life of the counter. Replacement counters can be obtained at your local scotty dealer or by contacting the factory directly (contact information can be found on page 16).

Fishing with Downriggers

Downrigger fishing is a whole new style of trolling. It may take a little while to get used to it, but after you begin to catch fish with it, you'll never go back to using heavy tackle. Unlike conventional trolling, the first evidence of a strike may show with just a wiggle of your rod tip or your downrigger pulley. When a fish strikes, your rod tip goes up, the line will momentarily go slack and you now have your fish on the line with no weight at all! Quite often, the fish will rush to the surface (with no weight to hold him down) and put up a spectacular fight right on top.

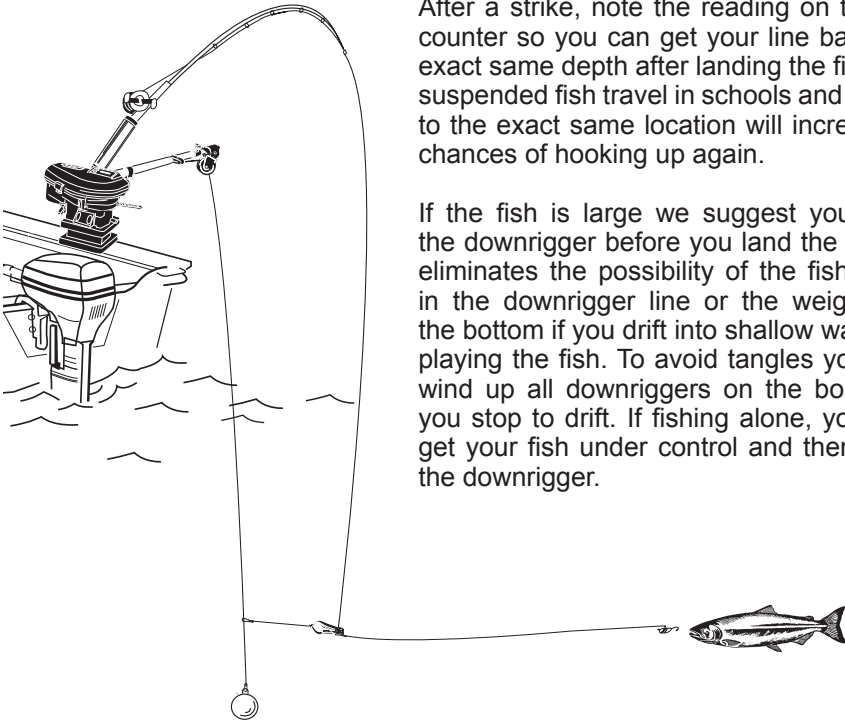

After a strike, note the reading on the depth counter so you can get your line back to the exact same depth after landing the fish. Many suspended fish travel in schools and returning to the exact same location will increase your chances of hooking up again.

If the fish is large we suggest you retrieve the downrigger before you land the fish. This eliminates the possibility of the fish tangling in the downrigger line or the weight hitting the bottom if you drift into shallow water while playing the fish. To avoid tangles you should wind up all downriggers on the boat before you stop to drift. If fishing alone, you should get your fish under control and then retrieve the downrigger.

Downrigger Safety

The Scotty High Performance 30" fixed and 60" telescoping boom electric downriggers are designed for use on wide beam boats of 16 ft. in length and up. Installation on smaller boats is not recommended. All sports have some physical hazards connected with them and fishing with downriggers calls for some common sense and precaution.

There are natural physical forces associated with long arm downriggers. The load or strain at the mounting point of a downrigger is proportional to the length of the arm. In the event of a bottom hang up with a 30" - 60" arm and high breaking strength trolling wire, the arm leverage can exert a tremendous force on the gunnel of your boat. It is obvious that this force could overcome a weak mounting point on the boat. In the case of a small boat, it could cause the boat to submerge or overturn if the wire is caught on the bottom in a strong tide or heavy wind.

Care must always be exercised to avoid tangling your downrigger wire in your boat prop. The best way to avoid this risk is to mount the downrigger near the stern of the boat so that the wire never gets under the boat in a turn. Sharp turns should be avoided if possible.

When the downrigger is tilted up, the boom must be tilted back past vertical, and the red lock lever tucked fully under the downrigger base.

Keep your fingers away from the underside of the downrigger base and always remove the weight when the downrigger is unattended or in the locked tilted position.

Make sure the area where you are mounting your downrigger is strong and reinforced. If it is weak, reinforce it with a backing plate of wood or metal.

Always try to bring weights, releases, and tackle inboard to you. When retrieving or hooking up, do not lean out, as a sudden roll or a slippery deck could send you overboard.

Do not attempt to retrieve a weighted or snagged downrigger cable by hand. Wave or boat motion could cause serious injury.

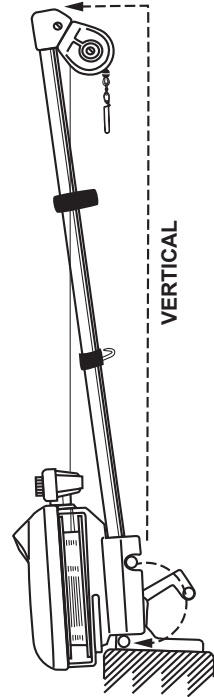

Red lock lever must be tucked under base to lock the downrigger upright. Always remove the weight when the downrigger is unattended or in the locked tilted position.

What happens when you hit bottom?

When your weight touches bottom while trolling, you will see the downrigger boom bounce. You should immediately bring your weight up to a safer depth.

WARNING! Be very cautious when fishing in strong tidal currents or on windy days. If the weight or wire snags on the bottom, the force of the tide or wind on the boat can put a terrific strain on the downrigger.

KEEP a pair of wire cutters handy in case you have to cut the wire in an emergency! Because of the built in tilt-up feature, the downrigger boom may fly up quickly when the wire breaks or is cut, so be sure to stand clear, not leaning over the boom.

We recommend you always have a large scale chart of your fishing area and know your position at all times when deep trolling. With a relatively smooth bottom, if your weight hangs up on a small ledge it can often be released by turning around and pulling from the opposite direction. The wire line can be paid out if necessary while you turn the boat to the direction of the hang-up. After a hang-up, the wire should be examined for any broken strands. If strands are broken, it can be cut and rejoined as a temporary measure but should be replaced as soon as possible.

Wiring Instructions and Installation

WARNING:

Batteries contain a large amount of potential electrical energy. Extreme care must be used when working with batteries. An improper connection to a battery can release enough energy to cause severe injury or fire.

PLEASE READ THROUGH ALL ELECTRICAL INSTRUCTIONS PRIOR TO INSTALLATION AND WIRING.

Required for Installation and NOT included with this kit:

- 30 amp fuse with fuse holder (Scotty part No. 1124)

Overcurrent Protection

The wiring between the battery and the receptacle must have proper overcurrent protection in the form of an inline 30-amp fuse. It is this inline fuse that may prevent an electrical fire in the event of a short circuit. Position the overcurrent protection within 7" of the battery.

Wire Gauge

Use good quality marine grade tinned electrical wire to bring power to your downrigger. To determine the correct gauge of wire, measure the "wire run length" which is the distance from the positive (+) power source connection, to your downrigger and back to the negative (-) power source connection. For wire run lengths up to 25 feet, use minimum 12 Ga. wire, for runs of 25– 40 feet use 10 Ga. wire. Wire smaller than the recommended gauge will not carry sufficient power to operate your downrigger at its rated speed and power, it will run noticeably slower.

We Recommend:

Scotty premium 12 gauge, 2 Conductor Downrigger Power Wire (Scotty part No. 1133) has been designed specifically for return runs of 25 feet or less. It is manufactured with heavy duty, annealed, tinned copper which provides maximum current flow and improved corrosion resistance.

NOTE: The downrigger should always be unplugged when not in use.

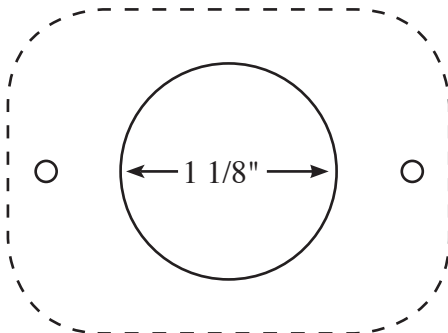

Receptacle template

Receptacle Installation & Wiring

It is important that the receptacle is wired to match how the plug is wired. The terminals marked "1" and "2" on the receptacle mate with the corresponding terminals marked "1" and "2" on the plug.

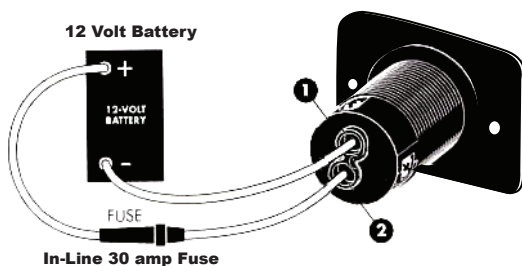

1. Mounting the receptacle requires a 1 1/8" hole to be drilled. Select a location where the boat's structure will not be weakened. Also, mount on a vertical surface to lessen the amount of water that can enter the receptacle. Alternatively, you may want to mount the receptacle using the Scotty L-bracket (included in your downrigger kit)
2. Using the template on page 6, mark and drill the required holes.
3. Slide the rubber receptacle protection boot onto the wire. Strip the wire insulation back 1/2" to expose clean bare wire. Do NOT solder the ends of the wires.
4. Feed the wire from the back, through the 1 1/8" hole. Insert the negative (-) wire into terminal "1" and the fused positive (+) wire into terminal "2" and tighten both terminal screws. Make certain there is no wire insulation inside the terminals and that there are no stray wire strands outside the terminals. Do not overtighten!
5. Mount the receptacle. Ensure the drain hole is facing down.
6. Push the rubber receptacle protection boot onto the receptacle from the backside.

Circuit Breaker

Your Scotty electric downrigger is equipped with an automatic circuit breaker to protect the motor from overload. If you hang up on bottom or snag a heavy mass of weeds and then push the power up button, the circuit breaker will probably trip. Wait 5 to 10 seconds for it to automatically reset and you will have power again. However, do not repeatedly attempt to lift a load too heavy for the downrigger motor. If possible, the downrigger line must first be freed from the obstruction.

Mounting Instructions

All Scotty electric downriggers mount on the Scotty No. 1023 tilt-up mounting bracket supplied with the downrigger. This bracket can be bolted directly to your gunnel or on top of an alternative mount (for additional mounting options see page 15). Downriggers can be mounted on either side of the boat, on the stern or on either corner. They will work in any location but the risk of tangling wire line in your prop while turning the boat is minimized the further back the downrigger is mounted.

You will be handling heavy weights and setting lines and releases, ensure your mounting location is convenient and safe for these operations. Do not mount the downrigger where you have to reach or lean a long way to make the connections. The addition of a Scotty Weight Retriever (Scotty part No.3025) will lessen the amount of reaching and leaning you may have to do.

Due to the heavy stresses placed on the boat gunnel by the leverage of the long downrigger arm, we recommend that a wood or metal backing plate always be installed on the underside of the mounting surface. This spreads the load and reduces damage to the boat in the event of a bottom hang up.

You should also consider rod holder mounting locations when deciding where to mount your downrigger. Scotty High Performance Downriggers come standard with either boom mounted or dual platform style rod holders. Another option is to move the boom rod holder body forward on your boom to accommodate even more rod holder options available from Scotty. You may choose to use the supplied rod holder as is, or mount additional rod holders on your boat. Rod holders work equally well when mounted either fore or aft of the downrigger.

Rigging Your Fishing lines

This section details the procedure of how to use your downrigger in conjunction with a fishing rod, read it carefully. It is best to rig your lines while your boat is in forward motion, this will help prevent tangles.

1. Once your downrigger is properly mounted, push the downrigger brake handle forward to ensure it is in the locked position. Attach your weight to the downrigger snap hook. Use enough weight to ensure the downrigger cable does not drag back at more than a 30 degree angle when travelling at trolling speeds. 12 to 15 lb. is adequate for most fishing conditions.

NOTE: Always keep tension on downrigger wire. Downrigger wire could kink or spill off spool edges if it becomes slack.

2. The AUTO STOP shuts off the downrigger when a line bead passes through it and triggers the shut off switch (line beads have already been installed on the downrigger cable). You can add more line beads at any point on the cable where you would like the downrigger to stop.
3. Ensure your line beads are present and properly located prior to using your Scotty Electric Downrigger
4. Have the AUTO STOP switch in the "OFF" position, pointing in line with the boom.
5. Connect the power source.
6. Lower the weight down approximately ten feet.
7. Turn the AUTO STOP switch to "ON" and your downrigger will stop as soon as your line bead enters the gate passage.
8. Your release clip should always be located at least five feet lower than a line bead.
9. Push the jog button to bring the weight or release clip up to the pulley.

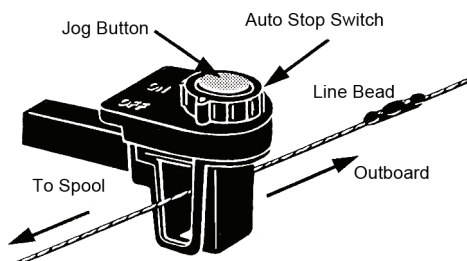

NOTE: The Scotty High Performance downrigger is equipped with a high speed, high torque motor. Extra caution should be observed when jogging your downrigger weight near the surface. When retrieving your weight near the surface you may want to apply the brake while pressing the jog button at the same time. This will help you retrieve the weight at a slower speed. This should only be done for the final few feet at the surface when you wish to lift your weight out of the water.

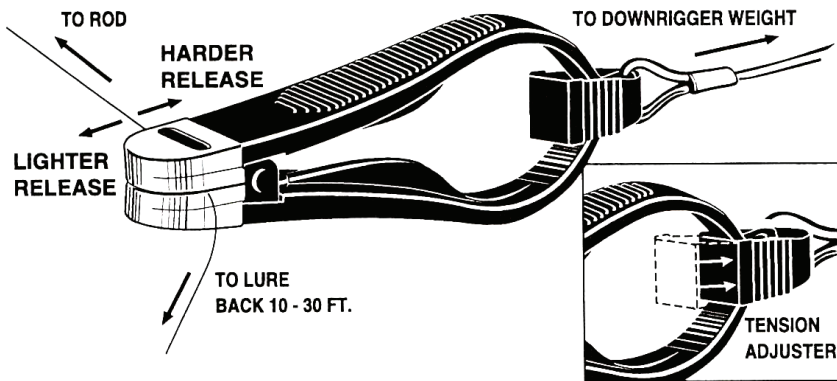

10. Clip the snap of the Power Grip release (included in your downrigger kit) to the downrigger weight, or if using a trolling snap style, a few feet up from the weight. Let between 5 - 30 ft. of fishing line out (with your bait or lure attached to the end) then attach your fishing line to the Power Grip release by squeezing the jaws apart and placing your fishing line between the pads (see diagram on page 3). You can adjust the release tension by placing the fishing line further into the jaws. To further increase the release tension you can move the tension adjuster slider to the out position.
11. With your fishing rod in a rod holder, set the tension on your reel so that the line will pay out, but with enough drag tension so that it doesn't free wheel. It is important to have your fishing line tight to the downrigger line because you may lose the fish if it has slack line after releasing from the downrigger release clip.
12. The downrigger weight is lowered by moving the brake handle in a clockwise direction. You can go as fast or as slow as you wish, but it is usually best to descend at a slow, even rate to eliminate fouling your fishing line and tackle with the downrigger cable.

After each use, it is advisable to rinse off your downrigger with fresh water to avoid salt build-up. The unit is made of non-corrosive materials, but a build up of salt and seaweed could affect performance.

Downriggers Do's and Don'ts

- DO** Check your downriggers clutch brake prior to each use to ensure it is correctly set.
 - DO** Check that your auto-stop line beads are present and properly located prior to each use.
 - DO** Attach your rod and reel line to your downrigger while your boat is in forward motion, this will avoid tangles.
 - DO** Read the depth counter when you catch a fish, then go back to the same depth.
 - DO** Replace cable regularly to avoid lost gear.
 - DO** Rinse off your downrigger with fresh water after each use, if used in saltwater.
 - DO** Clean power plugs regularly
-

- DON'T** Use heavier weight than fishing conditions require. Heavy weights reduce performance and efficiency, and shorten wire life. 12 - 15 lb. should be ample for most fishing conditions.
- DON'T** Let the downrigger wire go slack. Kinks may form or the wire could spill off spool edges.
- DON'T** Let your fishing reel spin free while you lower your downrigger, set a light drag.
- DON'T** Use nylon or other monofilament line on your downrigger. Nylon will stretch in use and shrink back on the spool with enough force to damage it. Use of Nylon line will void the downrigger warranty. *Use of Scotty brand braided line will not void your warranty*
- DON'T** Spray downrigger or wire with lubricants, oils or cleaners (ex. Armor All®), as these will damage the plastic, may cause brake malfunction and will void your warranty.
- DON'T** Attempt to retrieve a weight or snagged downrigger cable by hand. Wave or boat motion could cause serious injury.

Emergency Crank Handle

Before fishing with your Scotty Depthpower for the first time, you should familiarize yourself with the use of the Emergency Crank Handle **A**. This device is intended for use when a power loss has occurred and the weight must be retrieved.

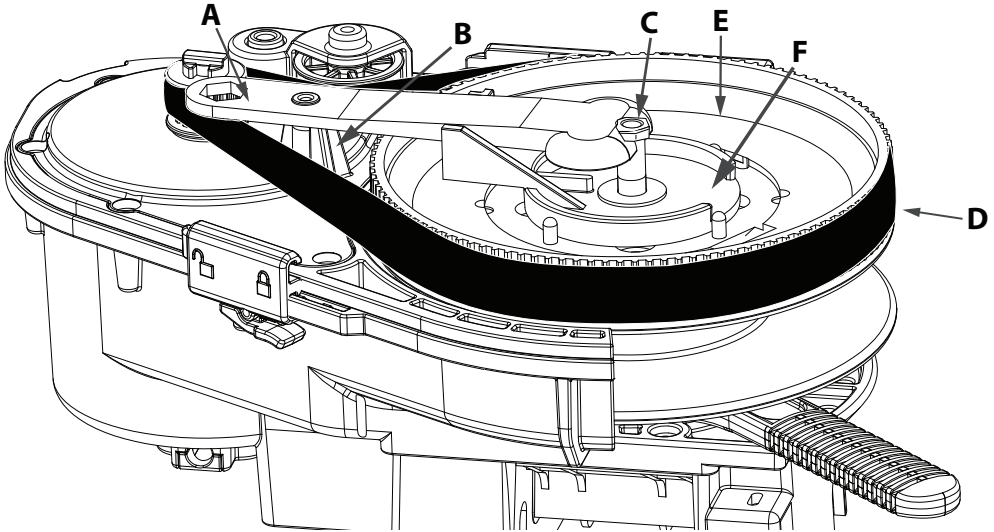

1. **DISCONNECT POWER TO THE DOWNRIGGER.**
2. Ensure the auto-stop control is in the off position.
3. Slide the latches on the front and back of the downrigger chassis to the 'unlocked' position and lift the lid off.
4. Immediately place the lid in a safe, inboard location to prevent accidental loss.
5. Lift the Emergency Crank Handle **A** off the locating pin **B** and pull it sideways off the nut **C**.
6. Lift the Drive Belt **D** off the spool gear **E** and put it in a secure place (inside the upturned lid is good).
7. Slide the non-forked end of the Emergency Crank Handle **A** into the slot on the top of the spool gear **E** at a 45° angle. You will now be able to crank up the wire line using the Emergency Crank Handle **A**.
8. The parts that have been removed should be installed in the reverse order they were taken off. Rotate the Counter Pressure Plate Assembly **F** so that the Emergency Crank Handle **A** is aligned between the supports. Lift the Emergency Crank Handle **A** over the locating pin **B** to engage its hole onto the pin.
9. The Emergency Crank Handle **A** must always be securely in place when the downrigger is in use under power, as it ensures correct alignment of the drive unit. Make sure the parts are reassembled correctly and the lid is properly positioned and locked before connecting the power.

Care And Maintenance

Your Scotty Electric Downrigger is constructed with corrosion resistant materials. The following regular maintenance checks should be performed:

1. Rinse with fresh water after every use.
2. Routinely check the stainless steel fastenings with a screwdriver to see that they are snug and secure.
3. Check the electrical plug connectors for corrosion and clean off any corrosion found. Failure to clean corrosion may cause electrical arcing and shorting which may be a potential fire hazard.
4. Do not use any lubricants. Lubricants will attack the plastic components and void your warranty.
5. Do not expose the downrigger to ultraviolet light for extended periods of time. A fabric cover (Scotty product No. 3015) is available to protect your downrigger from ultraviolet damage.

BRAKE ADJUSTMENT

Changes in temperature, humidity, and the weight you use will effect the performance of your clutch brake. You must ensure your brake is properly adjusted to allow the downrigger line to spool out in the event of a hang-up **prior to each use!** Proper brake setting is obtained when you have adjusted the downrigger brake to hold your weight in position when trolling but will pay out if it becomes snagged.

1. **DISCONNECT POWER TO THE DOWNRIGGER.**
2. Ensure the auto-stop control is in the off position.
3. Remove any weight from the line.
4. Slide the latches on the front and back of the downrigger chassis to the 'unlocked' position and lift the lid off
5. Immediately place the lid in a safe, inboard location to prevent accidental loss.
6. Move the brake handle to the "off" position so that the spool can move freely. Using a 9/16 inch wrench or the molded hex in the non-forked end of the emergency crank handle, either tighten or loosen the nylock nut as required to obtain the correct brake setting. Proper brake setting is obtained when you have adjusted the downrigger brake to hold your weight in position when trolling but will payout if it becomes snagged.
7. Make sure the lid is properly positioned and locked before connecting the power.
8. Test your clutch brake setting prior to use.

NOTE: The clutch brake system on your downrigger will require periodic adjustment and must be tested prior to each use. The brake pads and clutch brake system should last the lifetime of the downrigger without requiring replacement, just adjustment. Do not spray any lubricates or cleaners on your brake pads or any other components of your clutch brake system as this will void the warranty and may cause brake failure.

Care And Maintenance

WIRE MAINTENANCE

We have found many things can adversely affect the life of the wire. Included in these are such things as; an unobserved kink, electrolysis caused by stray electrical currents emanating from the boat, certain types of jelly fish and/or minute sea creatures which may have a corroding effect when left on the wire. Frequent inspection and wiping or washing wire with fresh water will help to prolong the wire's life span.

HOW TO REPLACE WIRE

1. **DISCONNECT POWER TO THE DOWNRIGGER.**
2. Mount the downrigger someplace secure (its regular boat mount is good) and pull off the old wire. When you come to the end of the wire, cut the loop off the downrigger spool.
3. Take the free end of the wire from the supply spool and thread it through the pulley, fairlead and the autostop. Thread the wire through the holes from the inside of the spool.
4. Tie an overhand knot in the wire, pulling it snug against the spool. Tie a second overhand knot giving you a "square knot" and pull it snug. Clip the excess line leaving a tail approximately 2 inches long. Secure the loose tail with tape to keep it from fouling the remainder of the wire line.
5. Wind the wire onto the spool using the Emergency Crank Handle. For directions on the use of the Emergency Crank Handle see page 12. Be sure to let wire unroll from the supply spool, rather than spill off the side. Avoid twisting or kinking the wire, keep tension on the supply spool to wind the new wire on as tight as possible. (This operation is best carried out with two people.)
6. Attach a new Scotty bumper and snap hook.
7. Ensure you add two new auto-stop line beads onto your downrigger line at least 5 ft. up from your Scotty Bumper and line clip. This will ensure your downrigger stops retrieveing before your terminal tackle hits the pulley.

NOTE:

Winding more than 300' of 180 lb. test wire onto the spool will affect accuracy of the depth counter.

Scotty utilizes the highest quality wire available. As there are many causes of wire breakage, wire is not subject to any warranty, expressed or implied.

Optional Mounts for your Downrigger

Right Angle Side Gunnel Mount

No. 1025

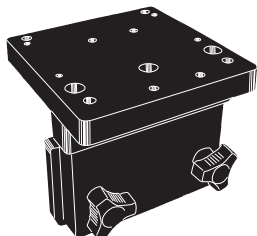

Pedestal Swivel Mount

No. 1026

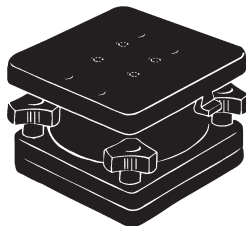

Rail Mount

No. 1027

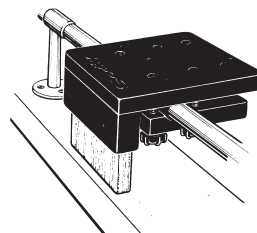

Gimbal Mount

No. 1028 - 9"

No. 1029 - 12"

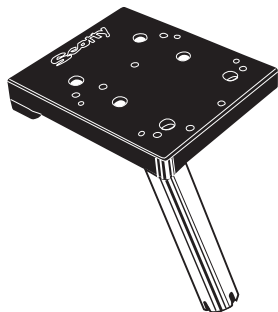

Pedestal Riser

No. 2606 - 6"

No. 2612 - 12"

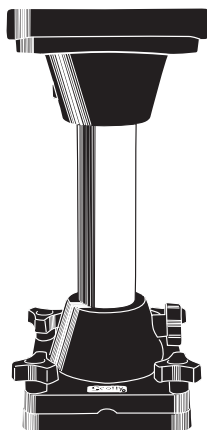

Dual Rod Holder

No.447

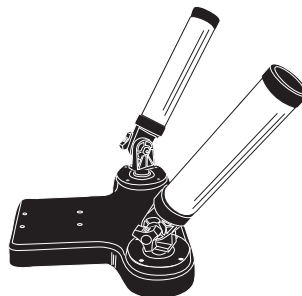

For more information on these and other Scotty products,
go to our website at www.scotty.com



The Way To Fish™

To obtain parts, information or to locate the warranty service depot nearest you, contact:

Scotty Fishing and Marine Products

2065 Henry Ave West
Sidney, BC Canada
V8L 5Z6

Tel: (250) 656-8102
Fax: (250) 656-8126
Toll Free: 1-800-214-0141
Email: scotty@scotty.com

www.scotty.com



Scan the above QR
code with your smart
phone

Although Scotty makes every effort to ensure the accuracy of specifications at the time of publication, specifications for products described in this publication are subject to change without notice.

Contact Scotty for the most current information.

Serial # _____